

# HANSER



Sample Pages

Ulf Bruder

User's Guide to Plastic

Book ISBN: 978-1-56990-573-9

**For further information and order see**

[www.hanserpublications.com](http://www.hanserpublications.com) (in the Americas)

[www.hanser-fachbuch.de](http://www.hanser-fachbuch.de) (outside the Americas)

Ulf Bruder  
**User's Guide to Plastic**

Ulf Bruder

# User's Guide to Plastic

A handbook for everyone

**The Author:**

*Ulf Bruder*, Bruder Consulting AB, Barkassgatan 9, SE-371 32 Karlskrona, Sweden

Distributed in North and South America by:

Hanser Publications  
6915 Valley Avenue, Cincinnati, Ohio 45244-3029, USA  
Fax: (513) 527-8801  
Phone: (513) 527-8977  
[www.hanserpublications.com](http://www.hanserpublications.com)

Distributed in all other countries by

Carl Hanser Verlag  
Postfach 86 04 20, 81631 München, Germany  
Fax: +49 (89) 98 48 09  
[www.hanser-fachbuch.de](http://www.hanser-fachbuch.de)

The use of general descriptive names, trademarks, etc., in this publication, even if the former are not especially identified, is not to be taken as a sign that such names, as understood by the Trade Marks and Merchandise Marks Act, may accordingly be used freely by anyone. While the advice and information in this book are believed to be true and accurate at the date of going to press, neither the authors nor the editors nor the publisher can accept any legal responsibility for any errors or omissions that may be made. The publisher makes no warranty, express or implied, with respect to the material contained herein.

*Disclaimer:*

We have done our best to ensure that the information found in this publication is both useful and accurate. However, please, be aware that errors may exist in this publication, and that neither the author nor Bruder Consulting AB guarantee the accuracy of the information. All the tradenames and registered trademarks occurring in this book are for identification purpose only and are the property of their respective owners.

The final determination of the suitability of any information for the use contemplated for a given application remains the sole responsibility of the user.

Cataloging-in-Publication Data is on file with the Library of Congress

Bibliografische Information Der Deutschen Bibliothek  
Die Deutsche Bibliothek verzeichnet diese Publikation in der Deutschen Nationalbibliografie;  
detaillierte bibliografische Daten sind im Internet über [<http://dnb.d-nb.de>](http://dnb.d-nb.de) abrufbar.

All rights reserved. No part of this book may be reproduced or transmitted in any form or by any means, electronic or mechanical, including photocopying or by any information storage and retrieval system, without permission in writing from the publisher.

© Carl Hanser Verlag, Munich 2015

Editor: Mark Smith

Production Management: Jörg Strohbach

Coverdesign: Stephan Rönigk

Printed and bound by Offizin Andersen Nexö, Leipzig, Germany

ISBN 978-1-56990-572-2

E-Book ISBN 978-1-56990-573-9

# Table of Contents

Foreword .....	4
1. Polymers and Plastics .....	5
2. Commodities .....	9
3. Engineering Polymers .....	19
4. Thermoplastic Elastomers .....	27
5. High-Performance Polymers .....	33
6. Bioplastics and Biocomposites .....	41
7. Plastic and the Environment .....	47
8. Modification of Polymers .....	51
9. Material Data and Measurements .....	59
10. Material Databases on the Internet .....	65
11. Test Methods for Plastic Raw Materials and Moldings .....	67
12. Injection-Molding Methods .....	73
13. Post-molding Operations .....	77
14. Different Types of Molds .....	81
15. Structure of Molds .....	87
16. Mold Design and Product Quality .....	93
17. Prototype Molds and Mold Filling Analysis .....	97
18. Rapid Prototyping and Additive Manufacturing .....	103
19. Cost Calculations for Moldings .....	111
20. Alternative Processing Methods for Thermoplastics .....	117
21. Material Selection Process .....	127
22. Requirements and Specification for Plastic Products .....	131
23. Design Rules for Thermoplastic Moldings .....	145
24. Assembly Methods for Thermoplastics .....	159
25. The Injection-Molding Process .....	165
26. Injection Molding Process Parameters .....	183
27. Problem Solving and Quality Management .....	185
28. Troubleshooting – Causes and Effects .....	195
29. Statistical Process Control (SPC) .....	215
30. Internet Links and Index .....	223

## Foreword

For many years, I have had the idea of writing a book about injection molding, as I have spent over 45 years of my working life on this subject.

When I retired in 2009 I was given great support by my friends Katarina Elnér-Haglund and Peter Schulz of the Swedish plastics magazine *Plastforum*, who asked me to write a series of articles about thermoplastics and their processing for the magazine.

I was also hired at this time to work with educational programs at the Lund University of Technology, the Royal University of Technology in Stockholm, and a number of industrial companies in Sweden—as a result of which this book was developed.

My aim has been to write in such a way that this book can be understood by everyone, regardless of prior knowledge about plastics. The book has a practical approach with lots of pictures and is intended to be used both in secondary schools, universities, industrial training, and self-study. In some of the chapters there are references to worksheets in Excel that can be downloaded free from my website: [www.brucon.se](http://www.brucon.se).

In addition to the above-mentioned persons, I would like to extend a warm thanks to my wife Ingelöv, who has been very patient when I've been totally absent in the "wonderful world of plastics" and then proofread the book; my brother Hans-Peter, who has spent countless hours on adjustments of all the images etc.; and my son-in-law Stefan Bruder, who has checked the contents of the book and contributed with many valuable comments.

I would also like to thank my previous employer, DuPont Performance Polymers and especially my friends and former managers Björn Hedlund and Stewart Daykin, who encouraged the development of my career as a trainer until I reached my ultimate goal and dream job of "global technical training manager." They have also contributed with a lot of information and many valuable images in this book.

I also want to say a big thanks to my friends and business partners in all educational programs in recent years, who have supported me and contributed with many valuable comments, information, and images for this book. The whole list would be very long but I would like to highlight some of them (in company order):

Kenny Johansson, Acron Formservice AB, Anders Sjögren, AD Manus Materialteknik AB, Michael Jonsson, AD-Plast AB, Johan Orrenius, Arla Plast AB, Kristian Östlund, Arta Plast AB, Eric Anderzon, Bergo Flooring AB, Anders Sjöberg, Digital Mechanics AB, Kristina Ekberg, Elasto Sweden AB, Frans van Lokhorst, Engel Sverige AB, Carl-Dan Friberg, Erteco Rubber & Plastics AB, Bim Brandell, Ferbe Tools AB, Niclas Forsström, Fristad Plast AB, Mattias Rydén, Hordagruppen AB, Lena Lundberg, IKEM, Magnus Lundh, K.D. Feddersen AB, Heidi Andersen and Lars Klees, Klees Consulting, Prof. Carl Michael Johannesson, KTH, Prof. Robert Bjärnemo, LTH, Oliver Schmidt, Materialbiblioteket, Joacim Ejeson, Nordic Polymers AB, Michael Nielsen, Nielsen Consulting, Marcus Johansson, Plastinject AB, Patrik Axrup, Polykemi AB, Edvald Ottosson, Protech AB, Thomas Bräck, Re8 Bioplastic, Thomas Andersson, Resinex Nordic AB, Martin Hammarberg, Sematron AB, Joachim Henningsson, Spring Slope, Nils Stenberg, Stebro Plast AB, Ronny Corneliusson and Tommy Isaksson, Talent Plastics AB and Jan-Olof Wilhemsson, Tojos Plast AB.

The Internet links to these companies and to some other companies who have also contributed information and images can be found on page 223 in the book.

Finally, I want to say a very big thanks to Vicki Derbyshire and Desiree von Tell, who helped translate this book, and to my friend Stewart Daykin who made the final check of both the language and the factual content.

Karlskrona, Sweden

*Ulf Bruder*

## Chapter 1 – Polymers and Plastics

Sometimes you get the question: What is the difference between polymer and plastic? The answer is simple: there is no difference, it's the same thing. The word "polymer" comes from the Greek "poly," which means many, and "more" or "meros," which means unity.

The online encyclopedia Wikipedia ([www.wikipedia.org](http://www.wikipedia.org)) states the following: "Polymers are chemical compounds that consist of very long chains composed of small repeating units, monomers. Polymer chains are different from other chain molecules in organic chemistry because they are much longer than, for example, chains of alcohols or organic acids. The reaction that occurs when the monomers become a polymer is called polymerization. Polymers in the form of engineering materials are known in daily speech as plastics."

By plastic, we mean that the engineering material is based on polymers, generally with various additives to give the material the desired properties, such as colors or softeners. Polymeric materials are usually divided into rubber materials (elastomers), thermosets and thermoplastics."

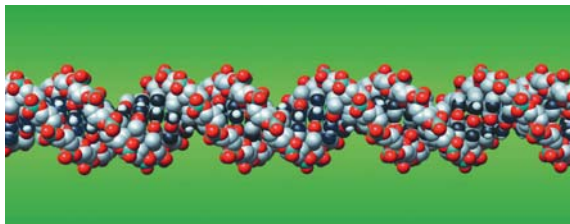

**Fig 1. Polymers are large macromolecules where monomer molecules bind to each other in long chains. There may be several thousand monomer molecules in a single polymer chain.**

Most polymers are synthetically produced, but there are also natural polymers such as natural rubber and amber that have been used by mankind for thousands of years.

Other natural polymers include proteins, nucleic acids, and DNA. Cellulose, which is the major component in wood and paper, is also a natural polymer.

In other words, plastic is a synthetically manufactured material composed of monomer molecules that bind to each other in long chains.

If the polymer chain is made up solely of one monomer it is called polymer homopolymer.

If there are several kinds of monomers in the chain, the polymer is called copolymer.

An example of a plastic that can occur both as homopolymer and copolymer is acetal.

Acetal is labeled POM (polyoxymethylene) and is mostly up-built of a monomer known as formaldehyde. The building blocks (atoms) in formaldehyde are composed of carbon, hydrogen, and oxygen.

Most plastic materials are composed of organic monomers but may in some cases also be composed of inorganic acids. One example of an inorganic polymer is a silicone resin consisting of polysiloxanes, where the chain is built up of silicon and oxygen atoms.

Carbon and hydrogen are the other dominant elements in plastics. In addition to the aforementioned elements carbon (C), hydrogen (H), oxygen (O), and silicon (Si), plastics typically consist of another five elements: nitrogen (N), fluorine (F), phosphorus (P), sulfur (S), and chlorine (Cl).



**Fig 2. Amber is a natural polymer. The mosquito in this stone got stuck in the resin of a conifer more than 50 million years ago—something to think about when considering the decomposition of certain polymers in nature.**

## Chapter 2 – Commodities

### Polyethylene (PE)

Polyethylene or polyethene is a semi-crystalline commodity, denoted as PE. It is the most common plastic, and more than 60 million tons are manufactured each year worldwide. “Low-density” polyethylene (LDPE) was launched on the market by the British chemicals group ICI in 1939.

#### Chemical facts:

Polyethylene has a very simple structure and consists only of carbon and hydrogen. It belongs to a class of plastics called olefins. These are characterized by their monomers having a double bond, and they are very reactive. The chemical symbol for ethylene, the monomer in PE, is  $C_2H_4$  or  $CH_2 = CH_2$ , where the “=” sign symbolizes the double bond. Polyethylene can be graphically described as:

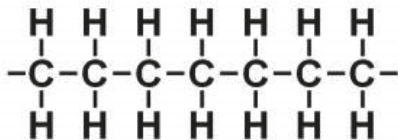

Fig 13. One reason that PE has become the main commodity is its extensive usage as a packaging material. Plastic bags are made of LDPE.

#### Classification

Polyethylene can be classified into different groups depending on its density and the lateral branches on the polymer chains:

- UHMWPE – Ultrahigh molecular weight
- HDPE – High density
- MDPE – Medium density
- LLDPE – Linear low density
- LDPE – Low density
- PEX – Cross-linked

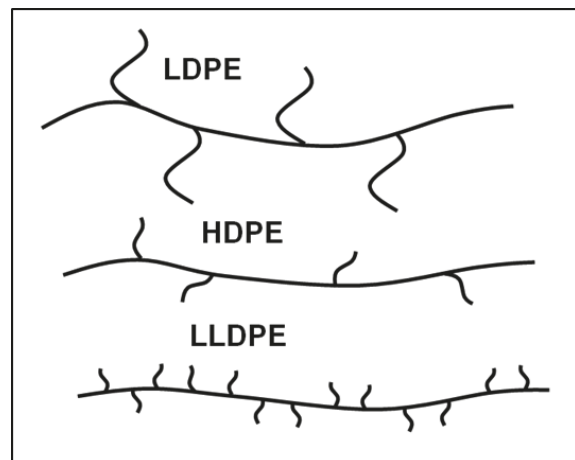

Fig 14. When polymerizing ethylene to polyethylene, there are various processes resulting in more or less lateral branches on the molecular chains. A smaller number of lateral branches give a higher crystallinity, molecular weight, and density, since the chains can thus be packed more densely. HDPE has few or no lateral branches and is also called linear polyethylene.

#### Properties of Polyethylene:

- |                                      |   |
|--------------------------------------|---|
| + Low material price and density     | + Excellent wear resistance (UHMWPE)    |
| + Excellent chemical resistance      | + Easy to color                         |
| + Negligible moisture absorption     | - Stiffness and tensile strength        |
| + Food-approved grades are available | - Cannot handle temperatures above 80°C |
| + High elasticity down to < - 50°C   | - Difficult to paint                    |

The mechanical properties depend largely on the presence of lateral branches, crystallinity, and density, i.e. the type of polyethylene.



## Chapter 3 – Engineering Polymers

### Polyamide or Nylon

Polyamide is a semi-crystalline engineering plastic, denoted by PA. There are several different types of polyamide, of which PA6 and PA66 are the most common. Polyamide was the first engineering polymer launched on the market. It is also the largest in volume since it is widely used in the automotive industry.

Polyamide was invented by DuPont in the United States in 1934 and was first launched as a fiber in parachutes and women's stockings under the trade name Nylon.

A few years later, the injection-molding grades were launched. Nylon became a general term; DuPont lost the trademark and currently markets its polyamides under the trade name Zytel. Ultramid from BASF, Durethan from Lanxess, and Akulon from DSM are some of the other famous trade names on the market.

### Classification

The development of polyamide has focused on improving the high-temperature properties and reducing water absorption. This has led to a number of variants where in addition to PA6 and PA66 the following types should be mentioned: PA666, PA46, PA11, PA12, and PA612. About a decade ago, aromatic "high performance" polyamides were introduced, usually known as PPA, which stands for polyphthalamide. The latest trend is "bio-polyamides" made from long-chain monomers, e.g. PA410, PA610, PA1010, PA10, PA11, and PA612.



#### Chemical facts:

Polyamide is available in a number of variations, labeled alphanumerically, e.g. PA66, indicating the number of carbon atoms in the molecules that make up the monomer. PA6 is the most common type of polyamide and has the simplest structure:

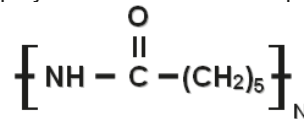

PA66 has a monomer that consists of two different molecules wherein each molecule has six carbon atoms, as illustrated below:

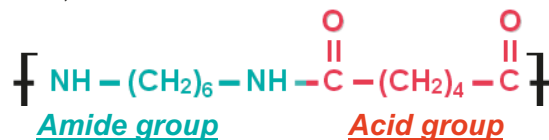

Fig 43. Polyamide has an excellent combination of good electrical properties, high operating temperatures, and flame-retardant capability (up to UL V-0 classification). The material is therefore used for electrical components such as fuses, circuit breakers, transformer housing, etc. Photo: DuPont

#### Properties of Polyamide:

- + Stiffness at high temperatures (glass fiber reinforced PA)
- + High service temperatures: 120°C constantly and a short-term peak temperature of 180°C
- + Good electrical properties
- + Food-approved grades are available
- + Can be made flame-retardant
- Absorbs excess moisture from the air, which alters the mechanical properties and dimensional stability
- Brittleness at low temperatures if not impact modified

Mechanical Properties	DAM	Cond.	Unit
Stiffness (tensile modulus)	3100	1400	MPa
Tensile stress (at yield)	82	53	MPa
Elongation at yield	4,5	25	%
Charpy notched impact strength + 30°C	5,5	15	kJ/m <sup>2</sup>
Charpy notched impact strength - 30°	4,5	3	kJ/m <sup>2</sup>

Fig 44. This table shows the mechanical properties of a standard quality of PA66 in a DAM, Dry As Molded, (unconditioned) state and after the material has absorbed 2.5% humidity at 23°C and 50% rel. humidity (conditioned state). The stiffness decreases by 65% and tensile strength by 35%, while toughness (elongation) increases five-fold. The impact strength at room temperature increases three-fold but drops by 33% at low temperature.

Source: DuPont

## Chapter 4 – Thermoplastic Elastomers

Thermoplastic elastomers (TPE) are soft thermoplastics with a low E-modulus and high toughness. Also called thermoplastic rubbers, their toughness is sometimes indicated by Shore A or Shore D to characterize them, as with rubber. Their chemical structure consists of both thermoplastic hard segments and elastic soft segments. The crucial difference to traditional rubber is the lack of, or at least very slight, cross-linking between the molecular chains. Most of the various TPEs offer a cost-effective alternative to rubber in a variety of applications, thanks to its suitability for different processes such as injection molding, extrusion, film, and blow molding. Feature-wise, however, rubber has the advantage of higher elasticity and lower compression under constant load. All the thermoplastic elastomers are ideal for material recycling, although incineration for energy extraction is also an option.

TPEs can generally be divided into the following groups:

- TPE-O, olefin-based elastomers
- TPE-S, styrene-based elastomers
- TPE-V, olefin-based elastomers with vulcanized rubber particles
- TPE-U, polyurethane-based elastomers
- TPE-E, polyester-based elastomers
- TPE-A, polyamide-based elastomers

### TPE-O

TPE-O (or TPO) thermoplastic elastomers, where the “O” stands for “olefin,” are a blend of polypropylene and EPDM uncured rubber particles. Because it has a PP matrix, TPO takes on a semi-crystalline structure. TPO-based elastomers are among the largest and most cost-effective TPEs available. They have been on the market since 1970, and leading manufacturers are Elasto, Elastron, Exxon Mobile, So.F.teR, and Teknor Apex.

By mixing the levels of EPDM in PP at concentrations from 10 to 65%, a great range of properties can be achieved. With mixture concentrations below 20% we usually call the materials impact modified PP, while levels above 60% give the more rubber-like properties. The recycling code for TPE-O is **> PP + EPDM <**.

### Properties of TPE-O

- + Cost-effective substitute for rubber
- + High stretch factor
- + Good tear resistance
- + Flexible at low temperatures
- + Good surface finish
- + Good chemical resistance
- + Can be UV stabilized
- + Easy to process
- + Can be colored
- + Paintable (primer required)
- Deformation properties (i.e. setting characteristics) not as good as rubber

#### Chemical facts:

The predominant TPO types are made up of monomers of polypropylene and uncross-linked EPDM rubber (ethylene-propylene-diene-monomer (M-class)). The properties depend on the monomer units where “n” can be 90–35% and “m” 10–65%.

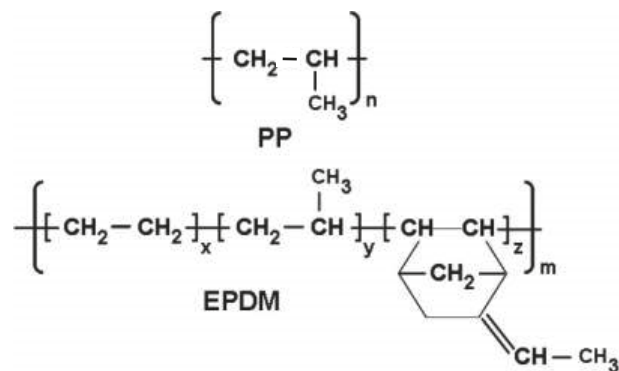

## Chapter 5 – High-Performance Polymers

### Advanced Thermoplastics

In everyday speech we describe this type of material as “high performance,” which means plastics with the best properties. What kind of qualities do we have in mind when developing materials to belong to this category?

Below we can see the wish list the researchers may have had when they set out to improve the properties of engineering plastics:

- Improved ability to replace metals
- Improved mechanical properties such as stiffness, tensile strength, and impact strength
- Increased service temperature
- Reduced influence of ambient temperature and humidity on the mechanical properties
- Less tendency to creep under load
- Improved chemical resistance (especially considering the fluids used in cars, i.e. fuel, oil, antifreeze, detergents)
- Improved flame-retardant properties
- Improved electrical insulation properties
- Less friction and wear
- Improved barrier properties (primarily to fuel and oxygen)

In addition, any new material would be required to:

- Have a reasonable price in relation to the properties it offers
- Be easy to process using conventional machinery
- Be simple to recycle

Advanced reinforcement systems with carbon and aramid fibers or coating with so-called nano-metals can also be used in combination with advanced polymers to achieve the above goals.

Plastics designed to replace metals are sometimes called “structural materials” and clearly have a great role to play in the future, especially since to date it is estimated that only 4% of the potential applications have been converted.

This section gives an overview of the following semi-crystalline advanced polymers:

1. Fluoropolymer (PTFE)
2. High-performance aromatic polyamide (PPA)
3. “Liquid crystal polymer” (LCP)
4. Polyphenylene sulfide (PPS)
5. Polyether ether ketone (PEEK)

And the following amorphous polymers:

6. Polyetherimide (PEI)
7. Polysulfone (PSU)
8. Polyphenylsulfone (PPSU)

### Recycling

All materials in this group can be recycled, and they have the material abbreviation in square brackets (e.g. > PTFE <) as their recycling code.

## Chapter 6 – Bioplastics and Biocomposites

### Definition

If you ask a professional “what is a bioplastic?,” you would get one of three different answers:

1. It is a plastic manufactured from biologically based raw materials.
2. It is a plastic that is biodegradable, i.e. can be degraded by microorganisms or enzymes.
3. It is a plastic that contains natural fibers.

Since biobased plastics are not necessarily biodegradable and biodegradable plastics do not have to be biobased, it is important to be clear about what you really mean. The percentage of renewable ingredients necessary for a plastic to be considered “bio” has not been established, although leading bioplastic suppliers deem that it should be at least 20%.

Plastics containing natural fibers are also called “biocomposites” and are mostly traditional plastics that have been reinforced or blended with natural fibers such as wood, flax, hemp, or cellulose.

In addition to the commodities PE and PP, there are also biopolyesters, such as PLA.



Fig 95. Some of the first thermoplastics were manufactured from cellulose, but they currently have little commercial significance, except for viscose fiber. Ping pong balls were originally made of celluloid and are still produced from cellulosic materials.

### What do we mean by Bioplastic?

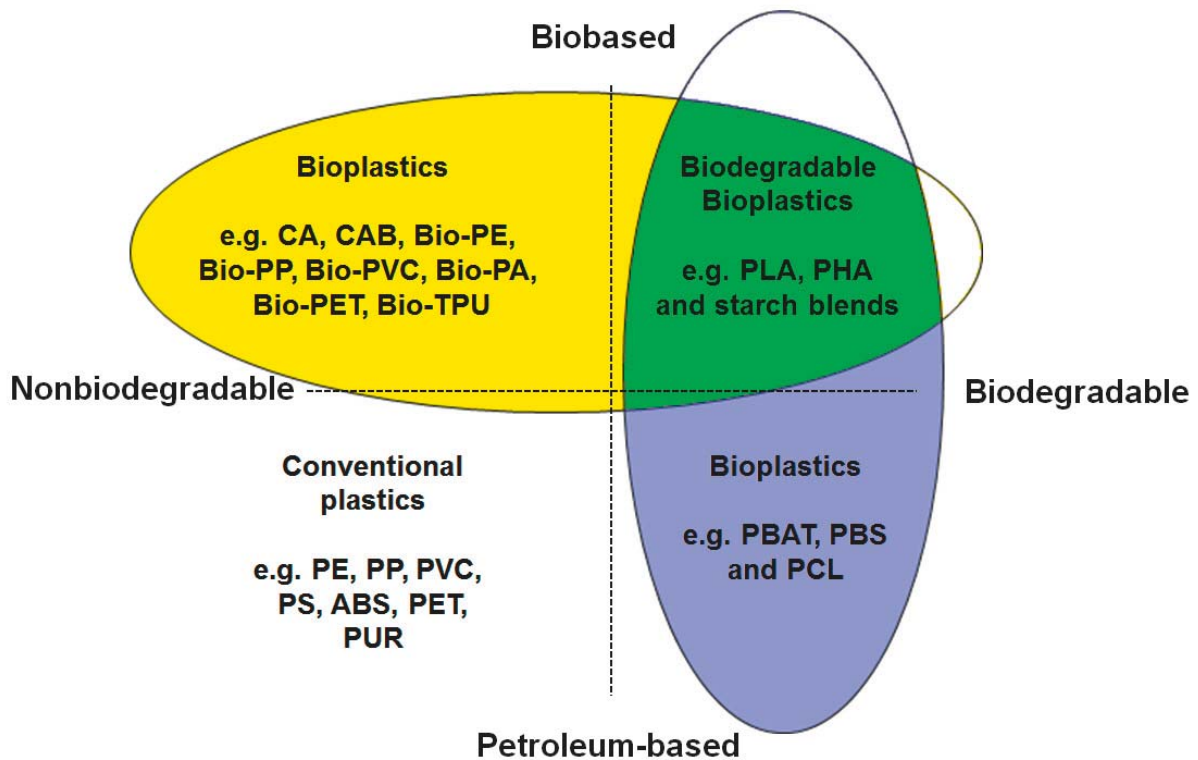

Fig 96. The illustration shows how to divide thermoplastics into conventional petroleum-based plastics and different types of bioplastics.



## Chapter 7 – Plastic and the Environment

At first glance, the title of this chapter may seem ambiguous. Do we mean how plastic affects our environment? Or how various environmental factors affect plastic? We will consider both aspects.

The use of plastics is constantly increasing. One important reason is the fact that plastics contribute to increased resource management—for example, saving energy and reducing emissions. Plastics also contribute to technological development.

The plastic industry wants to contribute to a sustainable society. That's why they invest considerable resources in the production of environmentally friendly materials and resource-efficient processes.



Fig 111. The use of plastics reduces our climate impact by saving energy and reducing CO<sub>2</sub> emissions.

### Plastic is Climate-Friendly and Saves Energy

That plastic can slow climate change by saving energy and reducing our emission of greenhouse gases is not something we may instantly think of. The recent study "Plastics' Contribution to Climate Protection" concluded that the use of plastic in the 27 EU member states plus Norway and Switzerland contributes to the following environmental benefits:

- Plastic products enable energy savings equivalent to 50 million tons of crude oil—that's 194 very large oil tankers.
- Plastic prevents the emission of 120 million tons of greenhouse gas emissions per year, which is equivalent to 38% of the EU's Kyoto target.
- The average consumer causes around 14 tons of carbon dioxide emission. Only 1.3% of that, about 170 kg, is derived from plastic.

In the automotive and aerospace industries, the use of plastic saves weight and thus reduces fuel costs. In the construction industry, plastic is increasingly used as a superior insulation material that provides a good indoor environment and reduces energy consumption.

**Fig 112. Plastic accounts for approx. 12–15% of a modern car's weight, which in Europe alone results in annual savings of 12 million tons of oil and a 30 ton reduction in CO<sub>2</sub> emissions. The body of this sports car is made of carbon fiber reinforced plastic and has an even higher proportion of plastic than an ordinary car.**



Without plastic, transportation costs for the retail industry would increase by 50%. On average, plastic packaging accounts for between 1 and 4% by weight of all products packaged in plastic. For example, a film that weighs 2 g is used to pack 200 g of cheese, and a plastic bottle weighing 35 g packs 1.5 liters of drink. If you also include containers and shipping material, then plastic packaging increases its share to 3.6% on average.

**Fig 113. A 330 ml glass Coca-Cola bottle weighs 784 g when full and 430 g empty (including the lid), i.e. 55% of the product weight is in the packaging. By comparison, a 500 ml bottle in PET is 554 g when full and just 24 g when empty (incl. lid), i.e. only 4% of the weight is packaging.**



Plastic also has many uses in climate-friendly energy production. For example, the wings of wind turbines are made of vinyl ester with internal PVC foam; pipes in solar collectors are made from polyphenylsulfone; and the casings for fuel cells are manufactured out of polyetherimide.

## Chapter 8 – Modification of Polymers

This chapter describes the polymerization of thermoplastics and how to control their properties by using various additives.

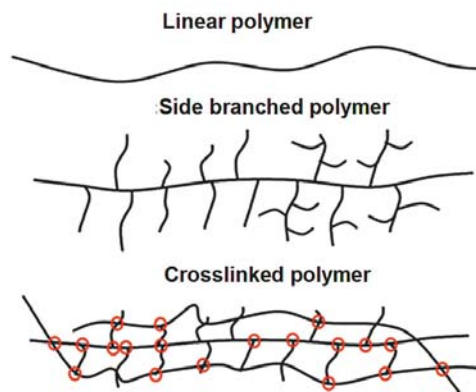

**Fig 123.** 95% of all the plastics produced are based on natural gas and oil. The remaining 5% comes from renewable sources, i.e. plants. In 2010 plastics accounted for about 4% of the total oil consumption, as follows:

• Heating	35%
• Transport	29%
• Energy	22%
• Plastic materials	4%
• Rubber materials	2%
• Chemicals and medicine	1%
• Other	7%

### Polymerization

The polymerization of monomers obtained by cracking of oil or natural gas creates polymers (synthetic materials) that can be either plastic or rubber. The type of monomer determines which type of material you get, while the polymerization process itself can create different variations of the molecular chains, such as linear or branched as shown below.



**Fig 124.** Polymerization of ethylene can produce different variants of polyethylene. LLDPE is made up of linear chains like the one at the top of the figure. LDPE has a branched chain structure, as shown in the middle. And PEX has cross-linked chains, i.e. where there are molecular bonds between the chains, as shown at the bottom.

If a polymer is made up of a single monomer it is called a homopolymer. If there are more monomers in the chain it is called a copolymer. Acetal and polypropylene are resins that can occur in both these variations. The copolymer group (the second monomer) is mainly located after the main monomer in the chain. In the case of acetal there are about 40 main monomers between every copolymer group. The copolymer may also occur as a side branch in the main chain, in which case it is known as a graft copolymer.

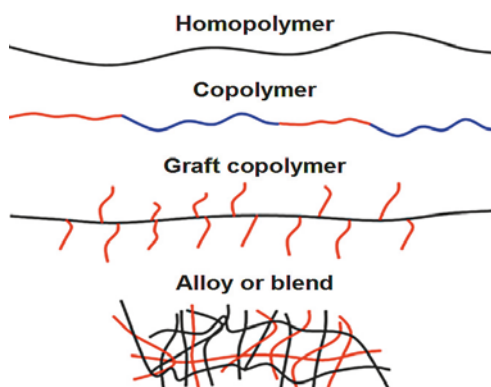

**Fig 125.** At the top we can see the linear chain of a pure polymer, such as polypropylene. By adding ethylene you get a polypropylene copolymer with a block structure according to the second chain from the top. This material has much better impact resistance than normal polypropylene.

By adding EPDM (rubber monomer) you get a graft polymer with a chain structure and a material with extremely high impact strength.

You can also create a copolymer by mixing the granules from different polymers. In this case, the material is known as an alloy or blend. ABS + PC is an example of this type of copolymer.





## Chapter 10 – Material Databases on the Internet

A good way to find information about different plastic materials is to visit the raw material producer's websites or visit independent material databases on the Internet. In this chapter you will find three leading global databases: CAMPUS and Material Data Center from the European company M-Base and the Prospector Materials Database from the U.S. company UL IDES. The great advantage of all the databases is that you can compare the material data no matter who the producer is, as all the materials in the databases are tested in exactly the same way.

### CAMPUS

About 20 large plastics raw material producers use CAMPUS to inform their customers about their products. Software for CAMPUS is offered free by the producers, and can be downloaded directly via the Internet: [www.campusplastics.com](http://www.campusplastics.com).

The database is updated regularly and can be updated via the CAMPUS website.

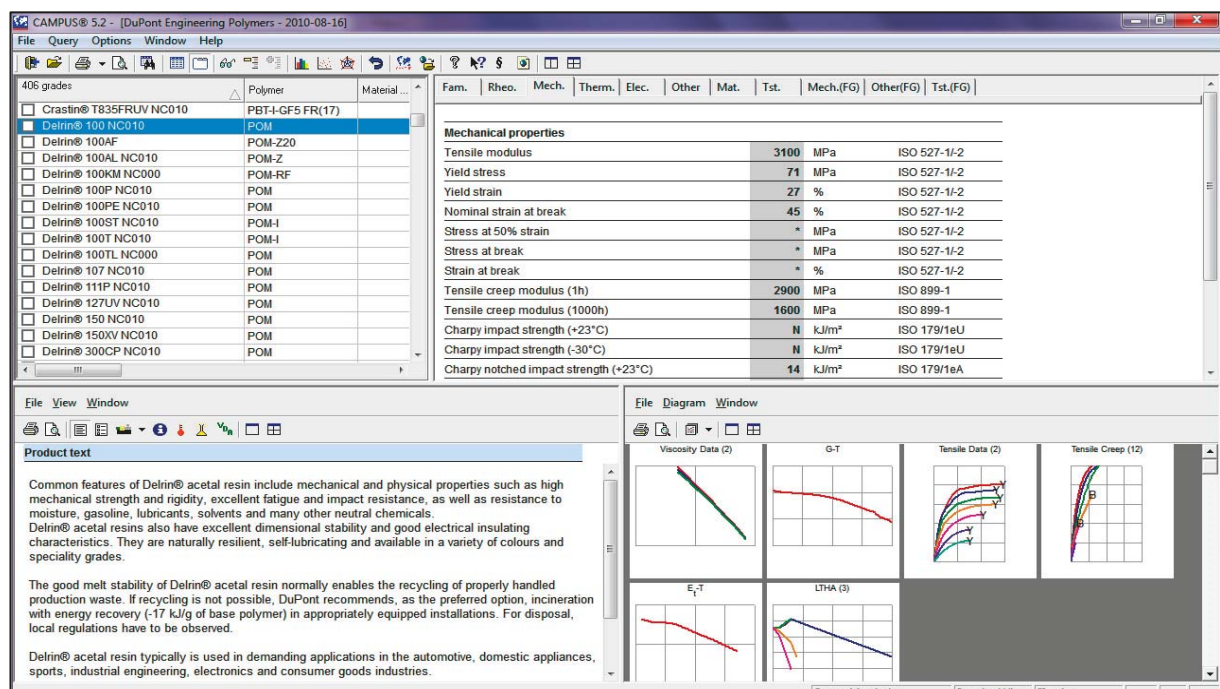

Fig 167. The CAMPUS window consists of four smaller windows. The top left is the list of all the materials. The top right is the properties window, which in this case shows the mechanical properties of the selected grade (Delrin 100 by DuPont). The bottom left is the information window with the information about Delrin 100, and to the right we can see the different curves for this material in the graphics window.

### Properties of CAMPUS 5.2

- + The database is free to download from the Internet
- + You can sort the properties in tables
- + You can compare different materials in a tabular form
- + You can compare different materials graphically
- + You can get chemical resistance for the materials
- + You can specify and print your "own" data sheet
- + You can search for materials meeting various criteria on properties
- + You can get the material process data in "curve overlay" and "polar" charts
- + You can get the material's flow properties (to be used in mold flow simulations)
- You can only compare materials from one specified material producer at a time
- The database must be updated manually



## Chapter 11 – Test Methods for Plastic Raw Materials and Moldings

In this chapter we will describe the plastic raw material producer's quality control data, the various material defects that a molder may find, as well as the test methods you can use when you want to analyze these kinds of defects.

### Quality Control during Raw Material Production

The plastic producers measure the quality of their plastic raw material at regular intervals (random sampling). Depending on the type of polymer and the included additives, they use different test methods during production. In general they are testing:

- Viscosity, which is dependent on the molecular chain length
- Fiber content, i.e. the ash content after complete combustion of the polymer
- Moisture content of each batch at the packing station

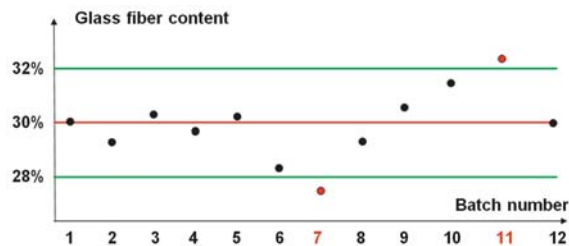

Fig 171. Here we can see the test results of 12 different batches of a 30% glass fiber reinforced grade. The aim is to be as close as possible to 30%, but as long as the result is within the green lines ( $30 \pm 2\%$ ), the material is approved for delivery. Batches 7 and 11 are not acceptable and must be redone in order to fall within the delivery limits.

	Test method (unit)	ISO	Specified.
A	Moisture content (%)	15512	$\leq 0.20$
A	Ash content (%)	3451	31 – 35
B	Melting point (°C)	3146	250 – 265
B	Density (g/cm <sup>3</sup> )	1183	1.34 – 1.41
B	Tensile strength (MPa)	527	$\geq 157$
B	Elongation (%)	527	$\geq 1.8$
B	Stiffness – E-modulus (MPa)	527	$\geq 8000$
B	Impact strength Charpy (KJ/m <sup>2</sup> )	179	$\geq 7.8$
B	HDT (1.80 MPa)	D789	$\geq 245$

A : Every batch, B : Annually

Fig 172. In the table to the left we can see that thermal and mechanical properties are tested at least once a year.

These values are then used for the published values in the producer's literature or in databases. It is only in exceptional cases that molders can get their material regularly tested with these types of testing.

The test values that the producers receive during the random sampling of the various production batches will as a rule be attached together with the material (or invoice) in the form of a delivery certificate. In this certificate you will find the same lot number (also called batch number) that you will find stamped on the bags or octabins. It is very important to keep these certificates in case of a complaint because the production plants always want information about the batch.

Fig 173. To the right you can see a delivery certificate from DSM for Akulon K224-G6 (natural PA6 with 30% glass fiber).

Here they have measured:

- Moisture content of 0.050% and indicated the upper delivery limit to be 0.150%
- An ash content (glass fiber content) of 29.9% and indicated the limits of supply to be between 28.0% and 32.0%
- A relative viscosity in a solution of formic acid of 2.45, which is well within the tolerance limits.

DSM Engineering Plastics B.V.



### Insp. certificate "3.1" EN 10204 Page 1 / 1

Material: Our / Your reference  
0000019277 K224-G6(99.99.99.171104 / 110-2372

Brandname: AKULON ®

Batch 1150341606 / Quantity 22.000 KG

Inspection lot 40000214809 from 07.09.2011

Characteristic	Unit	Value	Lower Limit	Upper Limit	Method
Moisture	%	0,050	0,000	0,150	ISO 15512
Ash	%	29,9	28,0	32,0	ISO 03451
Relative viscosity	-	2,45	2,20	2,60	DSM Method (90% HCOOH)

## Chapter 12 – Injection-Molding Methods

### History

Injection molding is the predominant processing method for plastics, allowing the production of parts in both thermoplastics and thermosets. In this chapter, however, we focus on injection molding for thermoplastics.

The method was patented in the U.S. back in 1872 by the Hyatt brothers, who began producing billiard balls in celluloid. The first molding machines were piston machines where the plastic material was filled in a heated cylinder. Once the plastic is thus melted, it is pressed into a cavity by means of the piston. The first screw machines, i.e. the type used today, were not introduced until the 1950s.

Injection molding has become the most popular machining process for thermoplastics today because it provides such great cost advantages over conventional machining or other casting methods. The process has also undergone great development in the last fifty years and is now completely computerized.



**Fig 194.** The picture shows an old piston injection-molding machine. The locking mechanism was a knee-joint type that is commonly used even today, but the locking and opening movements required arm muscles to operate the levers.



**Fig 195.** A modern injection-molding machine manufactured by Engel. This machine has a hydraulic locking mechanism. You can also get "all-electric" machines, which are significantly quieter than the hydraulic ones. Photo: Engel

### Properties

Injection molding is a completely automated process that often produces finished components in one go. In addition:

- + The components can be very complex in shape without any need for post-operations
- + It has a very high production rate (in extreme cases, with thin-walled packaging, a cycle time of only 3 to 4 seconds)
- + It can manufacture everything, from millimeter-size precision parts (e.g. gears in watches) to large body parts for trucks, with lengths over 2 m
- + It can fabricate really thin walls of just a few tenths of a millimeter, or thicker up to 20 mm
- + Several different plastic materials can be combined by co-injection in the same shot (e.g. a soft grip on a rigid handle)
- + Metal parts can be overmolded (Figure 196)
- + Components with so-called Class A surfaces (Figure 197), can be produced, suitable to paint or chrome-plate, as often seen on cars
- + Automated post-processing operations can easily be made, such as removing gates and runners, assembling (e.g. welding), or surface coating the components
- + Runners or rejected components can be directly recycled at the injection-molding machine

## Chapter 13 – Post-molding Operations

### Surface Treatment of Moldings

Generally, you get completely finished parts when performing injection moldings. Parts with the correct color are ready to be used immediately or ready to be assembled with other components. However, there are opportunities to further enhance improvements of the injection-molded part by surface treatment. Usually surface treatments are made to improve the aesthetic value but may sometimes be required to meet the functional needs.



Fig 211. A headlamp housing made in PBT

In this picture you can see the chrome-plated reflector through the glass (which has been made in polycarbonate). The surface treatment has been made in order to get the optic properties as well as adding protection to the surface from the high-heat-generating light sources.

The various surface treatment methods used for thermoplastics that we will cover are:

- Printing/labeling
- IMD, In-mold decoration
- Laser marking
- Painting
- Chrome plating or metalizing

### Printing

There are many different reasons for printing on plastic products. You often want to add a label or add instructions onto the surface of the product. The printing methods that we will describe in this chapter are:

- Hot stamping
- Tampon printing
- Screen printing



Fig 212. Containers, cans, and bottles with labels and instructions added to the surface. On many of these an adhesive label in either paper or plastic foil has been attached. There are also various methods to print directly on the plastic surface.

## Chapter 14 – Different Types of Molds

In this chapter we will cover different types of molds, and in the next chapter, we will look at them in more detail. If you ask an operator within the molding business what types of molds are commonly used, their likely reply is "common molds and hot runner molds." Hot runner molds will be discussed in the next chapter. What the operator probably means by "common molds" is shown below:

- Conventional two-plate molds
- Three-plate molds
- Molds with slides
- Molds with rotating cores for parts with inner threads
- Stack molds
- Molds with ejection from the fixed half
- Family molds
- Multi-component molds
- Molds with melt cores

The list covers most of the common types of molds but does not claim to be complete. In most of the above types, you can also choose between either cold or hot runner systems for the molds.

### Two-Plate Molds

Two-plate molds are the most common type of molds for injection molding.

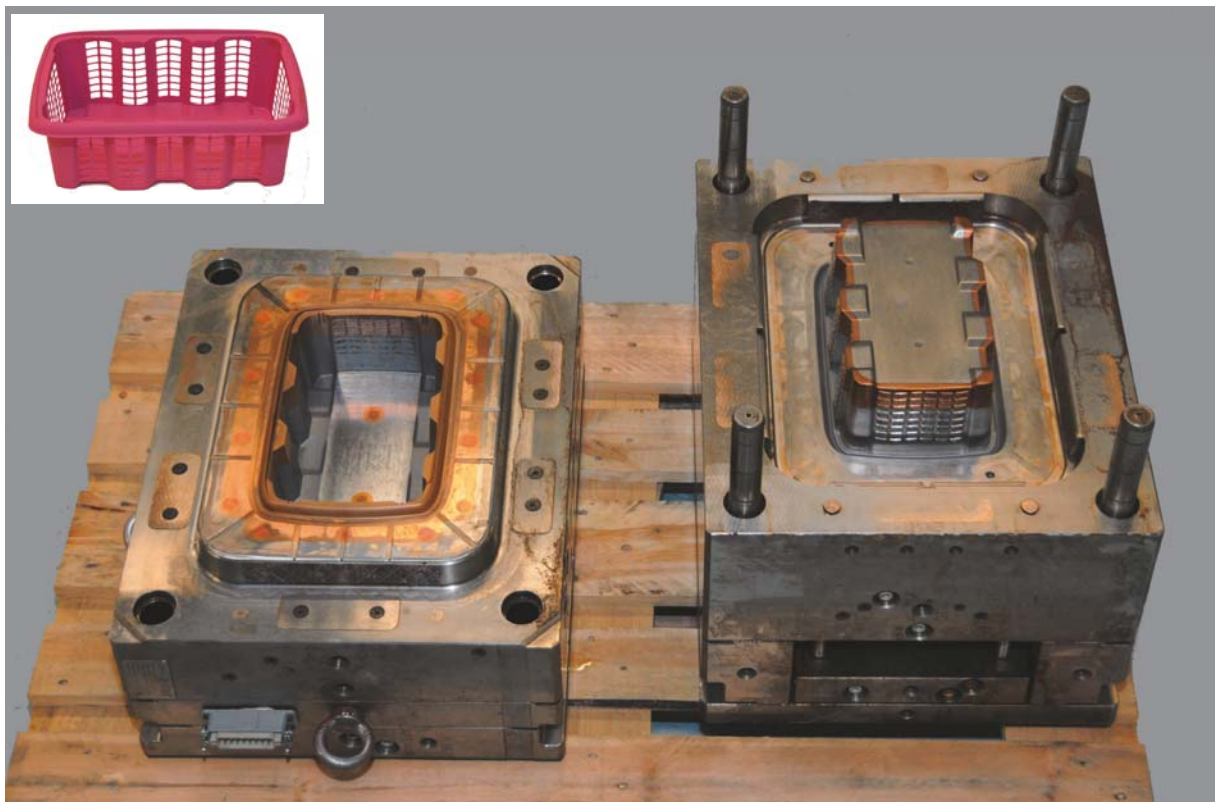

**Fig 223.** Here is an example of a two-plate mold with one cavity used to manufacture the basket shown in the picture at the top left corner. It is easy to see that the right half is the movable one, since the ejector plate (bottom) can be seen here. The left half is fixed and has a hot runner system integrated. The four columns are used to center the mold halves together.



## Chapter 15 – Structure of Molds

In this chapter we will focus on how a common two-plate mold is constructed.

We will look at the following:

- A. The function of the mold
- B. Runner systems – cold runners
- C. Runner systems – hot runner
- D. Cold slug pockets/pullers
- E. Tempering and cooling systems
- F. Venting systems
- G. Ejector systems
- H. Draft angles

Fig 234. To the right is a schematic diagram of the structure of a two-plate mold.

- ① shows the nozzle centering of the tool.
- ② shows the sprue and the channel between the nozzle of the cylinder and the runner.
- ③ shows the runner that leads the material through the gate into the cavities.
- ④ shows the gate that leads the material into the cavity.
- ⑤ is the cold slug pocket. ⑥ is the cooling system.
- ⑦ shows the ejector system.
- ⑧ shows the venting and ⑨ shows that the part has a draft angle.

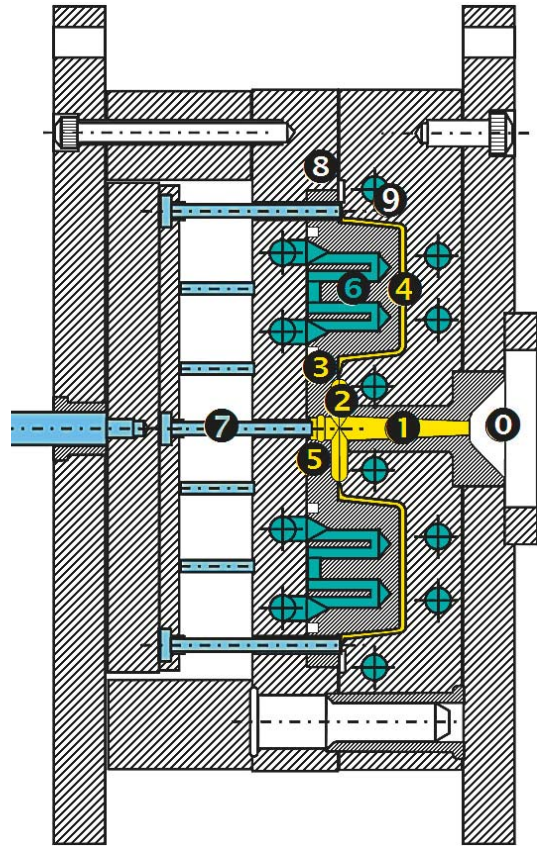

### A. The Function of the Mold

There are many demands on a mold in order to obtain high-quality products:

- The dimensions have to be correct
- Filling of the cavities has to be shear free
- Good venting is necessary during the filling process
- Controlled cooling of the plastic melt in order to obtain correct structure of the material
- Warp-free ejection of the part

### B. Runner Systems – Cold Runners

The cold slug pocket system can be divided into different parts:

1. The sprue
2. The runners
3. The gate

The sprue ① shown on the right is the connection between the cylinder nozzle and the runners ② of the mold. In most cases, it has a conical shape in order to avoid sticking in the mold when it has been packed. The sprue should be easy to pull out from the fixed half when the mold is opened at the end of the injection-molding cycle. For some semi-crystalline materials such as acetal the sprue can be cylindrical in shape. The dimensions of the nozzle should be adjusted with a diameter of about 1 mm less than the smallest diameter of the sprue.

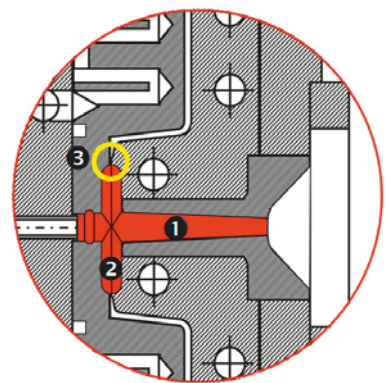

Fig 235. Above is the runner system. ① is the sprue, ② is the runner and ③ shows the location of the gate.

## Chapter 16 – Mold Design and Product Quality

In Chapter 11 problems that may occur on injection-molded parts due to defects in the plastic raw material are described. In this chapter we will look at problems due either to badly designed molds or improper part design. In Chapter 28 we will describe process-related problems.

### Mold-Related Problems

These types of problems are not always as easy to detect by visual inspection as material- or process-related problems are. Many of these problems are only discovered when the parts are mechanically tested or when the parts break under normal stress loads.

Below are some common problems due to:

- Too-weak mold plates
- Incorrect sprue/nozzle design
- Incorrect runner design
- Incorrectly designed, located, or missing cold slug pocket
- Incorrect gate design
- Incorrect venting
- Incorrect mold temperature management

### Too-Weak Mold Plates

If you get a flash around the sprue or runners during the injection phase, it may indicate too-high injection speed, too-low lock pressure on the machine, or too-weak mold plates.



Fig 252. In the picture to the left a fan shroud in acetal is shown.

The gate is in the middle, and it is clear that the mold plate has been deformed so that a flash around the gate has been formed even though the cavity is not completely filled. Moving the mold to a larger machine with higher clamping force did not help in this case.

In the case above, the first attempt to solve the problem was choosing an acetal grade with a lower viscosity. However, this did not solve the problem entirely (see the figure below to the left). Another option to solve the problem would have been to increase the wall thickness of the shroud or change the grid thickness in the round hole. Neither of these solutions were chosen; instead a solution using flow directors was used. The wall thickness was increased by using a honeycomb pattern (as shown on the figure below to the right).

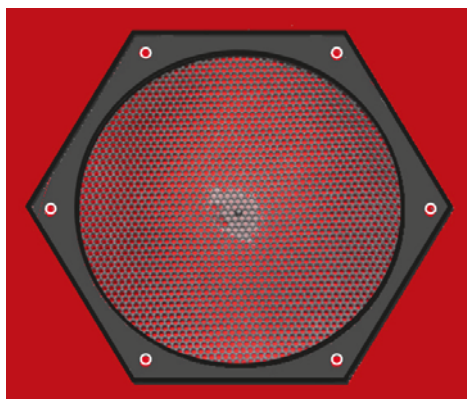

Fig 253. A less viscous grade of acetal with slightly less impact resistance was chosen to fill the fan shroud entirely, but still flash in the middle could not be avoided.

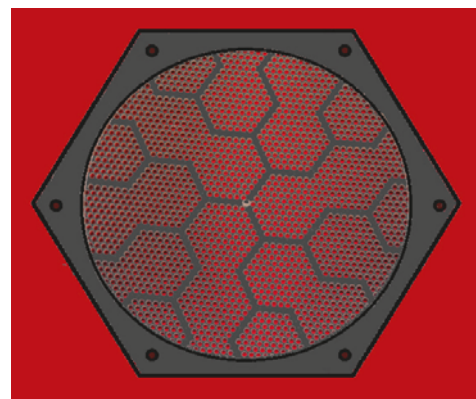

Fig 254. By applying a pattern of flow directors one succeeded to fill the shroud without getting the flash in the middle, nor did the cycle time need to be extended.

## Chapter 17 – Prototype Molds and Mold Filling Analysis

In the previous chapter we described various errors that depend on either an incorrect part or mold design.

When designing new parts or starting the molding of a new product, you will get a number of new questions and challenges:

- Will the part get the correct dimensions?
- Will it warp?
- Are the runners too long? Will the part be completely filled?
- Where should the gate be placed in order to make the part as strong as possible?
- Are the temperature-control channels correctly dimensioned and located?

### Prototype Molds

In order to avoid unpleasant surprises when starting the production in a new mold, you can use a prototype mold to see what the part would look like once it has been molded. Another option is to complete only one of several cavities in a production mold. These procedures could save both money and time. But they are not always completely reliable as runners, and mold temperature systems seldom correspond to the final production mold. Producers are using prototype molds when the plastic part is very complex or when the production mold is very expensive. Within the automotive industry these kinds of molds sometimes are named “soft molds” as they often are made in aluminum or in soft steel. When it comes to more simple part or mold design most prototypes have been replaced by a mold filling analysis.

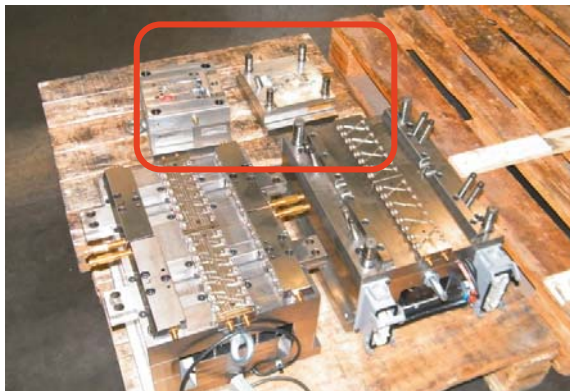

Fig 263. Above is a prototype mold (highlighted in red) in aluminum for the cams shown in the figure to the right. Here only one part is made in each shot. Below is the production mold in steel with 16 cavities. This mold is about 30 times more expensive to produce compared to the prototype mold in aluminum.



Fig 264. Here we can see a common component used in assembly of furniture. AD-Plast in Sweden developed this component in PPA with glass. They won the prestigious price “Plastovationer 2009” by successfully replacing metal with plastic. The cam is stronger than the former zinc one without needing to change the outer dimensions. Source: AD-Plast AB

### Mold Filling Analysis

Mold filling analysis is a computer-based tool that facilitates the ability to get accurate plastic parts in less time when producing a new part or modifying an existing mold.



Fig 265. On the image you can see a mold designer in front of his PC working with Moldflow, a mold filling software. Such software is able to run on standard PCs but requires a lot of computing power. In order for the calculations to run as fast as possible it is necessary to have a large internal memory as well as a fast processor.



## Chapter 18 – Rapid Prototyping and Additive Manufacturing

In the previous chapter we described various prototyping tools. In this chapter we will look at methods to produce prototypes or small production series without use of molds made of metal.

### Prototypes

The reason for using a prototype or model during the development process of a new product is that it:

- Shortens the development time so that the marketing process can start earlier
- Often facilitates communication between parties during the development process
- Enables opportunity to test various functions and/or interactions with other components
- Emotionally and physically can't be fully replaced by virtual models



**Fig 281.** Before computers were used in the development process of new products, prototypes and models were handmade. The picture to the left was taken at the Naval Museum in Karlskrona, Sweden. Here two admirals in the navy in 1779 make the decision to build a new battleship using a very detailed wooden model.

Producing models is something that humans have done throughout history. Most kids today get their first contact with models by playing with Lego or modeling clay. The advanced computerized technology of 3D manufacturing used today was developed in the late 1980s and has taken steps through CAD / CAE / CAM / CNC.

Which technique you choose depends entirely on the complexity of the part. If it is a part with simple geometry it is usually cheaper to produce it using cutting methods such as milling, laser, or water cutting. If the part is more complex, rapid prototyping (additive technology) may be the only possible solution or a much cheaper solution compared to cutting techniques even if the material is significantly more expensive (about 50 SEK/kg of plates in polyamide and 3000 SEK/kg for photopolymer in the SLA method). However, you must take into account that the production of milled models requires removal of up to 90% of the material, while the amount of material waste when using rapid prototyping is negligible.

### Rapid Prototyping (RP)

This kind of additive technology is fairly new and goes under a variety of names. When performing a search the following terms may be helpful: rapid prototyping (RP), rapid tooling (RT), rapid application development (RAD), additive manufacturing (AM), or 3D printing.

We will take a look at the following methods:

1. SLA – Stereolithography
2. SLS – Selective Laser Sintering
3. FDM – Fused Deposition Modeling
4. 3DP – Three-Dimensional Printing
5. Pjet – PolyJet



## Chapter 19 – Cost Calculations for Moldings

Most molders are using advanced computer-based software to calculate costs or post-costs of injection-molded parts. Unfortunately, it is very seldom that injection machine setters have insight into or get the opportunity to use such software, even though they have great potential to affect the costs by adjusting the injection-molding parameters.

How often does it happen that setters add a few seconds of extra cooling time when they have a temporary disturbance of the injection-molding cycle? And then forget to change back to the original settings before the parameters are saved for the next time the mold will be set up? Those extra seconds can mean thousands of Euros in unnecessary production costs per year and may also reduce the company's competitiveness.

The purpose of this chapter is to show how a fairly detailed cost calculation for injection-molded parts can be made. The setter also gets a tool that enables him/her to see how changes that are made in the process can influence the cost of the molded part. This tool is based on Microsoft Excel and is available for downloading at [www.brucon.se](http://www.brucon.se). The user does not need any extensive knowledge of Excel in order to fill in the input values required to immediately obtain the final cost picture at the bottom of the page.

The rest of this chapter will explain how to use the Excel file and what the different input values mean.

When you open the file called Costcalculator.xls you must first make a copy of this file to your computer's hard drive, otherwise the macro functions won't work. Depending on how the default values are set for your own Excel program, it may be necessary to make modifications of the security settings. Detailed information of how this is to be done can also be found on the author's homepage. The Excel file is also in "read-only" mode, so it should be saved under a different name once you have completed it.

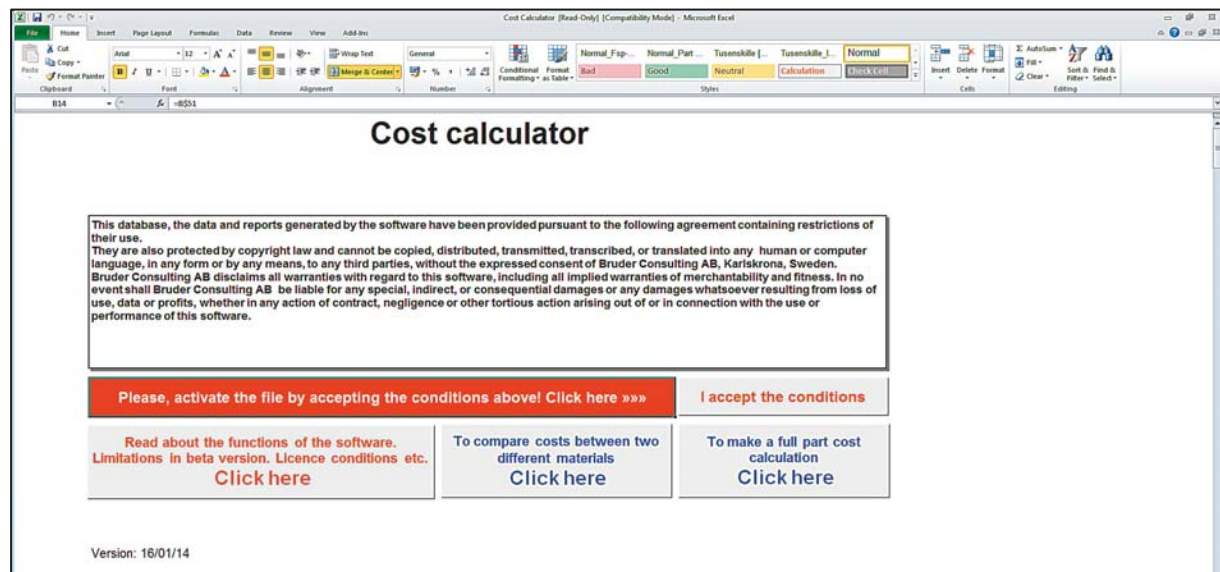

Fig 313. The start menu once the Excel file has been opened.

There are three different functions to choose between:

1. Read about the functions of this software
2. Compare the costs between two different materials
3. Make a full part cost calculation

Before you click on the key "I accept the conditions" you are only able to "Read about the functions of the software." The two other keys will only display blank pages.



Fig 314. Once you have clicked on "I accept the conditions" you will see "The file is active" as shown above, and all the different functions can now be used.

## Chapter 20 – Alternative Processing Methods for Thermoplastics

### Blow Molding

Blow molding is a fully automated process that produces hollow products from thermoplastic. There are two main variants. The first involves extrusion of a hollow tube, known as a “parison,” into a cavity between two mold halves (see the figure below). In the second, an injection-molded “preform” is heated and blown into the cavity (see the figure at the bottom of the page). Most PET soft drink bottles are produced in this way.

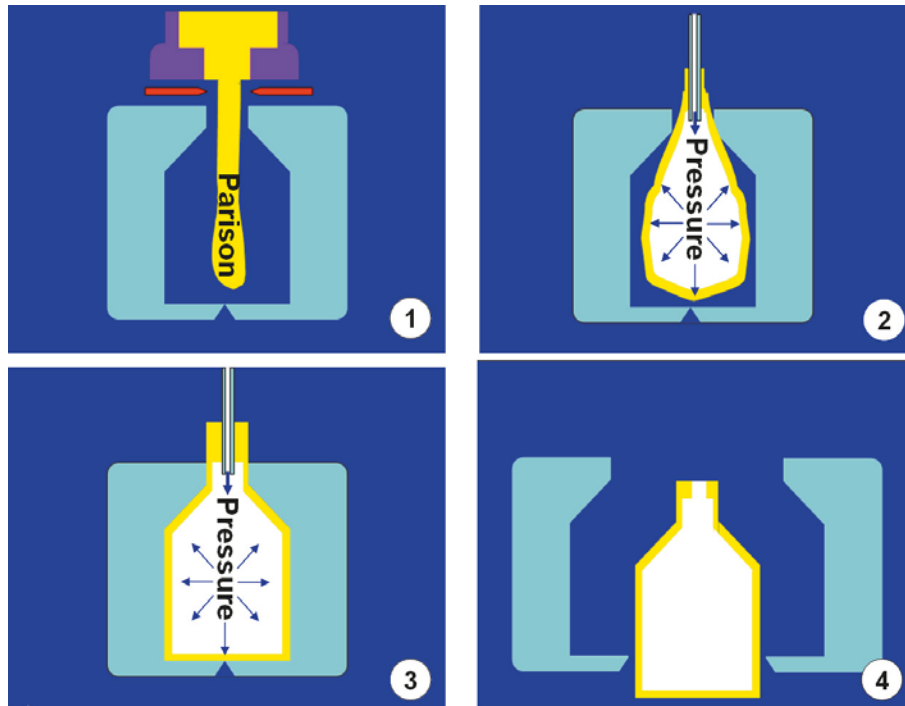

Fig 322. Blow molding with parison

Picture ❶ shows the extruded tube coming through the extruder head into the cavity.

In picture ❷ the mold has been moved to the next station, where the tube is blown out toward the walls of the cavity using compressed air.

In picture ❸ the tube has been completely pressed out against the cavity walls and allowed to cool.

Picture ❹ shows the finished part being ejected from the mold.

As a rule, only special grades with relatively high viscosity are used for blow molding, e.g. PE, PP, PVC, PET, PA, and some thermoplastic elastomers.

Multiple extruders can be used for different layers of the parison, for example to improve the barrier properties of a product. The hose can also be extruded in sequence, e.g. soft segments alternating with rigid ones to produce rigid tubes with integrated soft bellows.

## Chapter 21 – Material Selection Process

A major task of designers and project engineers is selecting the right material for their applications. When the materials under consideration include plastics, this task is particularly difficult, since there are hundreds of different polymers and thousands of different plastic qualities to choose from. Finding the right material requires knowledge, experience (your own or access to that of others), and sometimes a little luck.

If you choose a material that is considered "somewhat too good," this will usually be reflected in the cost being seen as "somewhat too high," which can have an effect on your competitiveness. However, on the other hand, if you choose a material of a "borderline" quality, you run the risk of complaints and a bad reputation in the marketplace, which also affects your competitiveness.

### How Do You Select the Right Material in Your Development Project?

Let's take a new iron as an example. Before the designer starts thinking about what materials to use in the iron, he must be clear about the following:

- What should the new iron look like?
- What different functions should it have?
- What will it cost?



When answering the above questions, the designer should make a list of the requirement specifications, as detailed as possible.

### Development Cooperation

A good way to reduce development time when it comes to plastic components is to utilize the collective expertise and experience of a project team consisting of its own development department working with a potential material supplier and potential manufacturers (e.g. molder and mold maker).

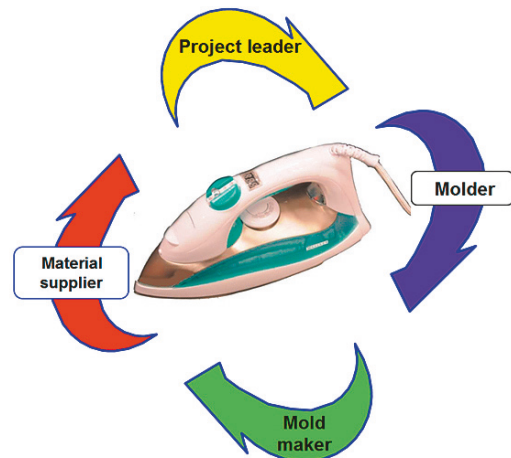

### Establishing the Requirement Specifications

To establish a complete requirement specification from scratch is very difficult. As a rule, one always encounters new challenges in development work. The requirements can be divided into categories:

1. Market requirements:
  - New functionalities
  - Regulatory requirements
  - Competitive situation
  - Cost objectives
2. Functionality requirements:
  - Integration of multiple functions in the same component
  - Different assembly methods
  - Surface treatments
3. Environmental requirements:
  - Chemical restrictions
  - Recycling (easy to disassemble and to sort)
4. Manufacturing requirements:
  - Processing methods (e.g. injection molding)
  - Molding equipment

Fig 349. Successful collaboration with project subcontractors generally shortens development time significantly.

## Chapter 22 – Requirements and Specification for Plastic Products

The requirement specification will differ from product to product depending on what it will be used for. For a spatula, heat resistance and food approval are key requirements; for the blade to an indoor hockey stick, toughness and the ability to shape the blade afterward are the most important properties. This section will address most of the properties that should be included in the requirement specifications of thermoplastic products. It is important to bear in mind that the tougher the requirements for a product, the more expensive it becomes to manufacture.

Below there is a list of the different things that need to be considered when drawing up the requirement specification for a new plastic product:

1. Background information
2. Batch size
3. Part size
4. Tolerance requirements
5. Part design
6. Assembly requirements
7. Mechanical load
8. Chemical resistance
9. Electrical properties
10. Environmental impact
11. Color
12. Surface properties
13. Other properties
14. Regulatory requirements
15. Recycling
16. Costs

### 1. Background Information

This generally refers to a description of the product and its intended usage and is often defined by the following questions:

- Have we developed a similar product?
- What new features will the product have?
- Is this just a new size (upscaling/downscaling) of an existing product?
- Can we modify the geometry of an existing product to create this new one?
- Does the new product require a radical change of materials?
- How do the competitors' products work?
- What tests, studies, or reports already exist regarding this type of product?

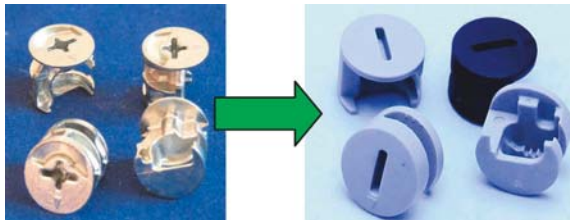

Fig 356. The picture on the left shows a zinc cam (furniture assembly screw). The cam in the picture on the right has the same dimensions but there has been a radical change to the material used: i.e. polyamide instead of zinc.



Fig 357. The picture above shows various sealing clips. Working from the left, clips 3 to 6 are purely upscaled/downscaled versions of the same product, whereas the other three clips have different geometries.



Fig 358. When collecting background information for the development of a new product, it is common to compare existing products on the market to try to find possible improvements, new functions, or lower production costs than your competitors.

## Chapter 23 – Design Rules for Thermoplastic Moldings

Designing in plastic is a science in itself, and a lot has been written on the subject. This chapter aims to show some of the most important rules that a designer should bear in mind when developing a new product in plastic. These rules are divided into the following ten sections:

1. Remember that plastics are not metals
2. Consider the specific characteristics of plastics
3. Design with regard to future recycling
4. Integrate several functions into one component
5. Maintain an even wall thickness
6. Avoid sharp corners
7. Use ribs to increase stiffness
8. Be careful with gate location and dimensions
9. Avoid tight tolerances
10. Choose a suitable assembly method

Fig 393. There is some good design literature online available for free download. One such document is “General Design Principles for DuPont Engineering Polymers” containing 136 pages of useful information.

See: [plastics.dupont.com/plastics/pdf/it/america/general/H76838.pdf](https://plastics.dupont.com/plastics/pdf/it/america/general/H76838.pdf)

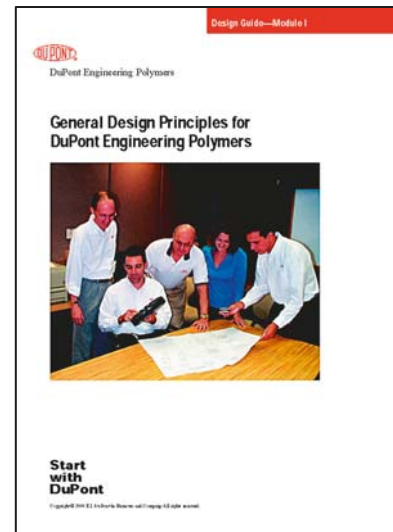

### Rule 1 – Remember That Plastics Are Not Metals

Some engineers still design plastic components as if they were made of metal. If you can succeed in maintaining the strength, the product will be lighter and often much cheaper. However, if the main purpose is to reduce production costs, it is by default necessary to make a total redesign when plastic is intended to replace metal.

If a direct comparison is made, the metal will have a higher:

- Density
- Maximum service temperature
- Stiffness and strength
- Electric conductivity

While the plastic material has an increased:

- Mechanical damping
- Heat expansion
- Elongation and toughness

	Metals	Thermoplastics	Thermosets
Weight	↔	↑↑	↑
Corrosion	↔	↑	↑
Stiffness	↔	↓↓	↓
Strength	↔	↓↓	↓
Temperature	↔	↓↓	↓
Thermal insulation	↔	↑	↑
Electric insulation	↔	↑	↑
Freedom of design	↔	↑↑	↑
Recycling	↔	↑	↓

↔ Reference / equal    ↑ Better    ↓ Worse

Fig 394. This table shows that thermoplastics have certain advantages over metals, such as decreased weight, corrosion durability, thermal and electric insulation, freedom of design, and recycling potential. However, they are clearly disadvantaged in terms of stiffness, strength, and sensitivity to high temperature. Thermosets follow the same patterns as thermoplastics but are much harder to recycle.



## Chapter 24 – Assembly Methods for Thermoplastics

Most designers seek to make their plastic products as simple as possible while at the same time integrating all the necessary functions. The product should preferably come out of the mold complete and ready, but sometimes—for functionality or cost purposes—it can be necessary to make the product in two or more parts that are assembled at a later stage.

There are several assembly methods for thermoplastic products, and this chapter considers most of them. To begin with, it is common to divide the assembly methods into those where the product can be disassembled and reassembled several times (e.g. using screw joints) and those permanent methods, whereby components are assembled only once (e.g. welding).

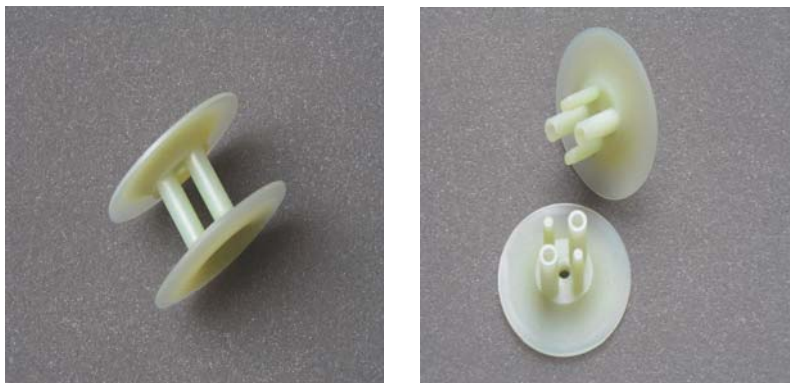

Fig 432 and 433. This bobbin is made as two identical halves in a mold with a simple parting line. The halves are then rotated 90° in relation to each other and then joined together by press-fitting.

### Assembly Methods That Facilitate Disassembly

Among the dismantlable methods, the following methods are usually used when it comes to plastic details:

- Self-tapping screws
- Threaded inserts
- Screw joints (with an integrated thread)
- Snap-fits (specifically designed to allow disassembly)



Fig 434. If a good screw joint is required for a self-tapping screw, the plastic material should have a stiffness lower than 2800 MPa (i.e. the same as for POM). For stiffer materials (e.g. glass fiber reinforced), a threaded hole or threaded inserts are recommended. It is also important to use a self-tapping screw that is specifically developed for plastic materials.

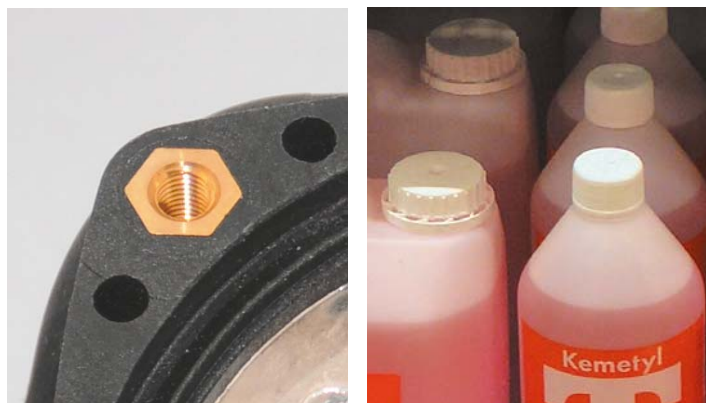

Fig 435 and 436. Above to the left is a threaded brass bushing in the wall of a pump housing made in glass reinforced polyamide 66. The bushing can either be over-molded or pressed into the plastic wall.

The plastic caps on the plastic bottles in the picture to the right are typical examples of a screw joint with integrated threads.

# Chapter 25 – The Injection-Molding Process

## Molding Processing Analysis

In this chapter, we will go through the main injection-molding parameters that affect the quality of the moldings. We will also emphasize the value of working systematically and having good documentation.

To the right there is a document called "Injection moulding process analysis." There is an Excel file that can be downloaded at [www.brucon.se](http://www.brucon.se). On this sheet we can record most of the parameters that need to be documented to describe the injection-molding process for a molded part.

This document was designed by the author of this book when he was responsible for the technical service at one of the leading plastic suppliers in the Nordic region.

You may think: Why should I spend time to fill it in when I can get all the parameters printed out directly from the computer system in my molding machine?

The answer is that you would probably drown in all the figures and only with difficulty find the cause of the problem. You would also have difficulties in finding the key parameters as the printouts from different machines are completely different.

This document is perfect for use both in problem solving and as a basis for process and cost optimization as well as for documenting a test drive or a start-up of a new job. If you fill in the document when the process is at its best you will have good benchmarks for comparison when there is a disturbance in the process. Therefore, we will closely examine the structure of this document and explain the meaning of the information in each input field. On the last page of this chapter is the document in full-page format.

## Contact Information

In the top part of the page there are some fields that can be filled in. If you only plan to use the page for internal documentation, it will probably be redundant to fill in these data.

However, you should always fill in the date and contact person. If after several years you need to go back and see how a particular setting was made, it is usually interesting to know who did it and then get additional information.

It is also important to know when the setting was made if several settings have been made over time.

If you use the document to communicate externally with a raw material supplier or a sister company, etc., it also facilitates this if the contact details are filled out.

Fig 456. The working tool "Injection moulding process analysis," which is described in this chapter.

Fig 457. Contact information.

## Chapter 26 – Injection Molding Process Parameters

In this chapter, we will publish the main injection-molding parameters for a number of thermoplastics.

When setting an injection-molding machine with a new resin, you should always use the recommended process data from the raw material producer if available. If you don't have them, look on the producer's website or search for them on the Internet.

**NOTE: The values shown in the tables in Figure 506 are typical for an unmodified standard grade of the polymer in question and serve only as a rough guide. Contact your plastic raw material supplier for accurate information about your specific grade!**

**The melt temperature** is one of the most important parameters. When processing semi-crystalline plastics, you should always consider the risk that you may get unmelted granules in the melt. To eliminate this risk, you should use the cylinder temperature profile that depends on the capacity utilization of the cylinder. See Chapter 25, page 171. You should also be aware that additives such as flame retardants or impact modifiers often require a lower temperature than the standard grade. Glass fiber reinforced grades should have, as a rule, the same temperature settings as unreinforced grades.

**The mold temperature** is also one of the most important parameters for achieving the best quality. For semi-crystalline plastics you need a certain temperature to ensure that the material's crystal structure will be correct and thus provide the best strength and dimensional stability (less post-shrinkage). See Chapter 25, page 173.

**Drying** is needed for plastics that are either hygroscopic (absorb moisture) or sensitive for hydrolysis (degraded chemically by moisture). See more in Chapter 25, page 170. We recommend that molders use dehumidifying (dry air) dryers in their production. Therefore we publish both the *temperature* and *drying time* needed to be below the maximum allowed moisture content for the material, provided that the dry air dryer is working with a sufficiently low *dew point*.

Note also that if you dry the material longer than the indicated time in the table you should reduce the temperature 10–20°C because some materials can oxidize or degrade thermally. Material where "*Needs normally not to be dried!*" is recommended in the table may still need to be dried if condensation will occur on the surface of the granules. If this is the case, a drying temperature of 80°C and a drying time of 1–2 hours usually works well.

The reason that the maximum **Peripheral speed** is published in the tables is that many molders in good faith are dosing up the next shot with too high of a screw speed and thus unnecessarily degrading the polymer chains in the cylinder by high shear and friction, resulting in poorer quality. On page 179 in Chapter 25 you will find a formula where you can calculate the maximum allowed peripheral speed to maximum allowed rotation speed depending on the screw diameter. If you cannot find the recommended maximum peripheral speed for your resin, you should take into account that high-viscosity grades sometimes require 30% lower rotation speed compared to a less viscous standard grade. For example, impact-modified acetal with a melt index of 1–2 g/10 min has a recommended maximum peripheral speed of 0.2 m/s, compared to 0.3 m/s for a standard grade with melt index of 5–10 g/10 min. For glass fiber reinforced grades you will usually find the recommended maximum peripheral speed to be 30–50% of the speed for the unreinforced grade. Also, impact modified, flame retardant grades used to be more sensitive to shear than standard grades.

Having sufficiently high **Hold pressure** is especially important for semi-crystalline plastics. Usually it is recommended to have as high a pressure as possible without getting flashes in the parting line or having ejection problems. We publish hold pressures because many molders sometimes in good faith set far too low a hold pressure, resulting in poorer quality.

Other important parameters such as hold pressure time, hold pressure switch, back pressure, injection speed, and decompression are more dependent on the part design and machine conditions. We therefore cannot give any general values of these parameters, but refer you instead to Chapter 25.



## Chapter 27 – Problem Solving and Quality Management

### Increased Quality Demands

The accelerating developments in both processing technology and thermoplastics have led to new uses, such as metal replacement, electronics, and medical technology. At the same time, the demands on plastic components have increased when it comes to performance, appearance, and other characteristics. The slightest deviation from the requirements and specifications must immediately be addressed, and thus the goal for many molders is to deliver error-free products (zero tolerance) while keeping their own rejects below 0.5% at high utilization of their machines. We can no longer accept the previous "hysterical" troubleshooting methods, where changes in the process parameters (sometimes several at the same time) immediately were made without any detailed analysis of the problem as soon as there was an unacceptable deviation from the specifications. To meet the increasing and intense competition, you have to work with both statistical problem-solving methods and process control. In this chapter we will describe some of these:

- ATS: Analytical troubleshooting
- DOE: Design of experiments
- FMEA: Failure mode effect analysis

In the next chapter, we will describe a large number of errors that can occur during injection molding of thermoplastics and how to solve them.

### Analytical Troubleshooting - ATS

The word "problem" is often used with different meanings, such as production problems, decisions, and plans to be implemented. This diversity can create a lot of confusion when it comes to communication with others.

Working on problems in a systematic and organized way within the area of "analytical troubleshooting" (ATS) requires very specific definitions of the word "problem." This leads to an improvement in communication and understanding among the parties involved.

### Definition of the Problem

A problem always consists of a *cause* and an undesirable *deviation*. Below is an example of this.



Fig 507. The black specks that you can see on the red button of the safety belt lock are an unacceptable deviation. It is normally defined as a surface defect.

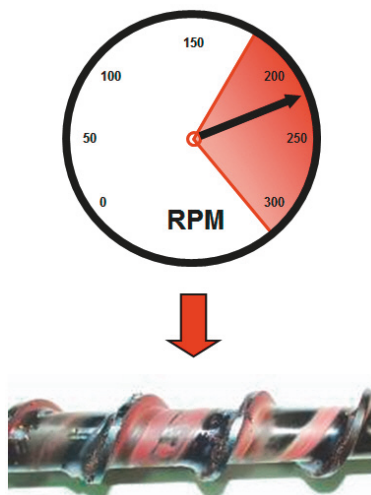

Fig 508. The cause of these black specks is usually the use of too-high screw speed in the injection-molding machine. This leads to a screw deposit on the surface of the screw that degrades thermally and causes the specks on the surface of the button.

## Chapter 28 – Troubleshooting – Causes and Effects

### Molding problems

In the previous chapters we dealt with defects caused by bad material. In this chapter we will discuss process-related errors. These can generally be divided into the following main groups:

- 1) Fill ratio, which means unfilled or overfilled parts
- 2) Surface defects
- 3) Strength problems
- 4) Dimensional problems
- 5) Production problems

In general, process problems belong to several of the main groups.

In order to identify and classify a problem and then find possible causes for it, you should ask the following questions:

- 1) What kind of problem is it?
- 2) What has changed?
- 3) When did this happen?
- 4) Where do the error/errors occur:
  - On the part / parts (the same place or randomly)?
  - In the production cycle?
- 5) How often does it occur?
- 6) How serious is it?

PROBLEM / DEVIATION ANALYSIS Please use the tab key when completing the page

Product  Part no.  Customer  Reset

Contact person  Phone no.  E-mail  Date

WHAT has happened? Deviation from Setpoint:

Space for photo

Click here before the photo file is pasted

WHERE was the problem / deviation discovered? Click here after the photo file has been

At our quality control  At our assembly line  At our customer  By the consumer

WHERE on the part / parts was the problem / deviation discovered?

On a single part  Parts from all cavities  On the same spot  All over the part

WHEN was the problem / deviation discovered?

At starting up  Change of shift  Change of batch  By ocular inspection

WHO discovered the problem / deviation?

Frequency. How often is the symptom / deviation?

When in the life cycle does the problem / deviation occur?

The problem / deviation occurs: How and then?  Very rarely  Has never earlier been observed

HOW serious is the problem / deviation?

Few parts  Quantity that needs to be fixed:  Priority: High  Medium  Low

Classification of the problem / deviation:

Small disturbance  Recurring problem  Starting up problem  Complex problem  Warning signal

Other comments:

CAUSAL ANALYSIS Please use the tab key when completing page

Reset

Probable ROOT CAUSE (in a complex problem it may be more than one):

Material dependent  Process dependent  Mold dependent  Incorrectly designed part

CAUSES (List the most likely causes in the most logical order):

1.
2.
3.
4.
5.

The above CAUSES can be verified by:

1.
2.
3.
4.
5.

Actions needed to be taken to correct the existing problem:

Actions needed to be taken to prevent the existing problem:

Actions needed to be taken on other machines / molds / equipment or procedure changes:

Other comments / solution to the problem:

Fig 522. Forms for the analysis of problems in Excel format are available at [www.brucon.se](http://www.brucon.se).

We will now describe a wide range of common and uncommon errors that can occur during the injection-molding process. We have also tried to list the causes of the most probable ones in a logical order, based on a large number of troubleshooting guides issued by leading plastic suppliers.

**NOTE:** When troubleshooting, it is important that the material supplier's process recommendations for the relevant material are available to adjust any incorrect settings.

## Chapter 29 – Statistical Process Control (SPC)

Statistical process control is a method that has long been used in the engineering industry to improve the quality of produced products. Regarding the production of plastic products it has not yet been put into use on a large scale (2014). SPC among molders is, however, largely increasing. In this chapter we will give the reader an orientation on the principles and different concepts used. This chapter has been developed together with Nielsen Consulting ([www.nielsenconsulting.se](http://www.nielsenconsulting.se)), a Swedish consultant who specializes in SPC training and has contributed with text and images.

### Why SPC?

SPC is a very useful and profitable method because it:

- **Creates customer value**, i.e. improves the function or extends the lifetime of the customer's product
- **Reduces rejects** by focusing on the tolerance center (see terms below) instead of the tolerance limits
- **Prevents failure** of the products because actions are taken at the right time
- **Reduces the need for final inspection**, i.e. deliveries with high capability (see terms below) don't need a final inspection
- **Promotes customer relations** because capability allows the customer to take the goods without performing an incoming inspection
- **Detects machine failure** at an early stage and thus becomes an aid in state-based maintenance
- **Reduces inventory costs** by error-free deliveries and allows a reduced inventory
- **Can reduce stress** in production as the need to measure and control the process is reduced
- **Can facilitate price discussions** as accurate deliveries usually mean more satisfied customers
- **May increase staff engagement** through increased understanding of the process as it is easier to see patterns and trends in the process
- **Provides a uniform approach** when there is no room for "sole and absolute discretion"
- **Is a tool in the Lean process** that provides continuous improvement with focus on satisfying the customer

### Definitions in SPC

#### **Normal Distribution (Gaussian Dispersion)**

This is the way in which the measured values, in most cases, will be distributed as a result of the random spread around its mean value (highest point of the hump); see the figure to the right.

Notice that most of the measured values are around the hump and that there are fewer values closer to the periphery. It is in other words not very likely that you at all, under random sampling, will find some details at the periphery. It is not enough that the details that you happen to measure fall within the tolerance range. To see the Gaussian dispersion many details need to be measured, and it may be time consuming. But there is a shortcut by using the standard deviation!

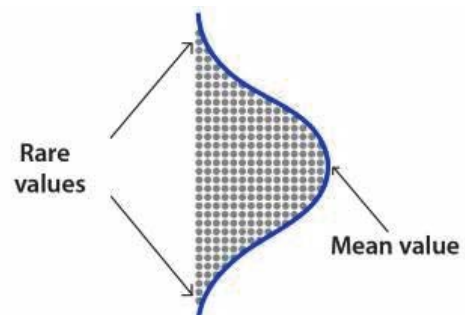

Fig 560. Normal distribution and mean value.

## Chapter 30 – Internet Links and Index

### Internet Links

The following companies have contributed with information and/or photos for this book and are highly recommended if you need more information about their products or services:

Company	Internet link	Product or service
Acron Formservice AB	<a href="http://www.acron-form.se">www.acron-form.se</a>	Rapid prototyping
Ad Manus Materialteknik AB	<a href="http://www.ad-manus.se">www.ad-manus.se</a>	Training/testing/analysis
AD-Plast AB	<a href="http://www.ad-plast.se">www.ad-plast.se</a>	Injection moldings
Arkema	<a href="http://www.arkema.com">www.arkema.com</a>	Plastic raw material
Arla Plast AB	<a href="http://www.arlaplast.se">www.arlaplast.se</a>	Extrusion
Arta Plast AB	<a href="http://www.artaplast.se">www.artaplast.se</a>	Injection moldings
Bergo Flooring AB	<a href="http://www.bergoflooring.se">www.bergoflooring.se</a>	Plastic flooring
Clariant Sverige AB	<a href="http://www.clariant.com">www.clariant.com</a>	Masterbatch
Digital Mechanics AB	<a href="http://www.digitalmechanics.se">www.digitalmechanics.se</a>	Rapid prototyping
Distrupol Nordic AB	<a href="http://www.distrupol.com">www.distrupol.com</a>	Plastic distributor
DuPont Engineering Polymers	<a href="http://plastics.dupont.com">plastics.dupont.com</a>	Plastic raw material
DSM	<a href="http://www.dsm.com">www.dsm.com</a>	Plastic raw material
DST Control AB	<a href="http://www.dst.se">www.dst.se</a>	Electro-optical systems
Elasto Sweden AB	<a href="http://www.elastoteknik.se">www.elastoteknik.se</a>	Thermoplastic elastomers
Engel Sverige AB	<a href="http://www.engelglobal.com">www.engelglobal.com</a>	Injection molding machines
Erteco Rubber & Plastics AB	<a href="http://www.erp.se">www.erp.se</a>	Plastic distributor
European Bioplastics	<a href="http://www.en.european-bioplastics.org/">www.en.european-bioplastics.org/</a>	European trade organization
Ferbe Tools AB	<a href="http://www.ferbe.se">www.ferbe.se</a>	Tool maker
Flexlink AB	<a href="http://www.flexlink.com">www.flexlink.com</a>	Conveyors
Hammarplast Consumer AB	<a href="http://www.hammarplast.se">www.hammarplast.se</a>	Storage products
Hordagruppen AB	<a href="http://www.hordagruppen.com">www.hordagruppen.com</a>	Blow moldings
IMCD Sweden AB	<a href="http://www.imcd.se">www.imcd.se</a>	Plastic distributor
Injection Mold - M Kröckel	<a href="http://www.injection-mold.info">www.injection-mold.info</a>	Mold graphics
IKEM	<a href="http://www.ikem.se">www.ikem.se</a>	Swedish trade organization (training)
K.D. Feddersen Norden AB	<a href="http://www.kdfeddersen.com">www.kdfeddersen.com</a>	Plastic and machine distributor
Makeni AB	<a href="http://www.makeni.se">www.makeni.se</a>	Injection moldings
Mape Plastic AB	<a href="http://www.mapeplastics.se">www.mapeplastics.se</a>	Plastic distributor
Mettler Toledo AB	<a href="http://www.se.mt.com">www.se.mt.com</a>	Equipment for analysis
Miljösäck AB	<a href="http://www.miljosack.se">www.miljosack.se</a>	Climate-smart plastic bags
Nordic Polymers Sverige AB	<a href="http://www.nordicpolymers.dk">www.nordicpolymers.dk</a>	Plastic distributor
Novamont S.p.A.	<a href="http://www.novamont.com">www.novamont.com</a>	Bioplastics
Plastinject AB	<a href="http://www.plastinject.se">www.plastinject.se</a>	Injection moldings
Polykemi AB	<a href="http://www.polykemi.se">www.polykemi.se</a>	Plastic raw material
Polymerfront AB	<a href="http://www.polymerfront.se">www.polymerfront.se</a>	Plastic distributor
Polyplank AB	<a href="http://www.polyplank.se">www.polyplank.se</a>	Recycled products
Protech AB	<a href="http://www.protech.se">www.protech.se</a>	Rapid prototyping equipment
Re8 Bioplastic AB	<a href="http://www.re8.se">www.re8.se</a>	Bioplastics
Resinex Nordic AB	<a href="http://www.resinex.se">www.resinex.se</a>	Plastic distributor
Rotationsplast AB	<a href="http://www.rotationsplast.se">www.rotationsplast.se</a>	Rotational moldings
Sematron AB	<a href="http://www.sematron.se">www.sematron.se</a>	Vacuum forming
Stebro Plast AB	<a href="http://www.stebro.se">www.stebro.se</a>	Injection moldings
Talent Plastics AB	<a href="http://www.talentplastics.se">www.talentplastics.se</a>	Injection moldings and extrusion
Celanese	<a href="http://www.celanese.com">www.celanese.com</a>	Plastic raw material
Tojos Plast AB	<a href="http://www.tojos.se">www.tojos.se</a>	Injection moldings
Vadstena Lasermärkning	<a href="http://www.lasermarkning.se">www.lasermarkning.se</a>	Laser marking equipment
Weland Medical AB	<a href="http://www.weloc.com">www.weloc.com</a>	Plastic clips

## Index

A		Creep	147
ABS	15	Crystalline	7
Acetal	21	Cushion	181
Action planning	190	Cycle time	179
Actual value	186	D	
Additives	52	Degradable	41
Advanced thermoplastics	33	Delamination	90
AFS	185	Design rules	145
Air bubbles	207	Deviation chart	186
Air streaks	201	Diesel effect	199
Amorphous	7	Discoloration	198
Analytical troubleshooting	185	Dosing	180
Anisotropy	138	Dosing time	179
Aromatic polyamide	35	Draft angle	92
Assembly methods	159	Dry air dryer	170
Atactic	52	Drying	172
B		DuraPulp	44
Back pressure	177	E	
Biocomposites	46	Ejection	92
Biodegradable	41	Ejection problems	212
Bioplastic	41	Ejector pin marks	205
Biopolyamides	45	Electrical properties	64
Biopolyester	44	Electron microscope	72
Biopolymers	43	Elongation at yield	60
Black specs	198	Environmental impact	48
Blisters	201	Extrusion	119
Blow molding	117	F	
Brittleness	208	Factorial	191
Burns	198	Failure definition	185
C		Failure mode effect analysis	193
Cable production	124	Family mold	84
CAMPUS	65	Fill rate	196
Capability	218	Film blowing	123
Cause verification	188	Flammability	63
Cellulose	43	Flammability test	70
Charpy	62	Flash	196
Chemical properties	55	Flexural modulus	61
Chrome plating	80	Fluoroplastic	34
Cold slug	205	FMEA	193
Cold slug pocket	89	G	
Color streaks	200	Gas bubbles	207
Compostable plastics	43	Gas injection	76
Conical gate	156	Gate	88
Control chart	216	Gate design	156
Control limit	216	Glass fiber streaks	202
Cooling	90	Glass transition temperature	8
Cooling time	179	Gluing	164
Copolymer	51	Goal value centering	218
Corner radius	154	Granulation	52
Cracks	207		
Crazing	209		

H		Melt index	64
HB-classification	63	Melt temperature	172
HDPE	9	Melting point	8
Heat deflection temperature	62	Metalization	80
Heat stabilization	57	Microtome cut	72
High performance nylon	35	Monomer	51
Hold pressure	175	Mold	81
Hold pressure switch	182	Mold failure	93
Hold pressure time	175	Mold filling simulation	97
Hold up time	179	Mold shrinkage	64
Hot air dryer	170	Multi-component injection	76
Hot channel mold	89	Multi-component mold	85
Hot plate welding	162		
Hot-stamp printing	78	N	
Hygroscopic	170	Nonlinear	146
		Normal distribution	215
I		Notch sensitive	154
IMD	79	Nozzle	169
Impact strength	61	Nylon	19
Injection-molding cycle	75		
Injection-molding economics	103	O	
Injection-molding failure	195	Oil stains	206
Injection-molding machine	74	Orange peel	204
Injection-molding methods	73		
Injection-molding process	165	P	
Injection pressure	174	PA	19
Injection speed	177	Painting	80
Injection time	177	Part cost calculation	111
Injection unit	74	PBT	23
IR spectrophotometer	71	PC	25
IR welding	162	PE	9
Isotactic	52	PEEK	38
Izod	62	Peripheral speed	179
		PET	23
J		PEX	9
Jetting	203	PHA	45
		Physical properties	54
L		Pigment orientation	201
Laser marking	79	PLA	44
Laser welding	163	Plastic	5
LCP	36	PMMA	17
LCPA	45	Polyamide	19
LDPE	9	Polycarbonate	25
LLDPE	9	Polyester	23
Locking unit	75	Poly ether ketone (PEEK)	38
Lot number	166	Polyethylene	9
		Polymer	5
M		Polymerization	51
Machine capability	220	Polymethyl acrylate	17
Masterbatch	54	Polyphenyl	40
Material data	59	Polypropylene	11
Material Data Center	65	Polystyrene	14
Material selection	127	Polysulfone	39
MDPE	9	Polyvinyl	13
Mean value	215	POM	21
Mechanical properties	53	Post-mold shrinkage	174
Melt core mold	86		



PP	11	Stiffness	59
PPA	35	Strain curves	60
PPC	37	Stress-strain curves	60
PPSU	40	Stress concentration factor	154
Printing	77	Stringing	214
Problem analysis	188	Styrofoam	14
Process capability	220	Suck-back	180
Prototype molds	97	Surface coating	77
PS	14	Surface defects	198
PSU	39	Surface gloss	202
PTFE	34	Syndiotactic	52
PTT	44		
PVC	13	T	
Pyrometer	172	Tampon printing	78
		Temperature profile	171
Q		Tensile	59
Quality control	67	Tensile modulus	60
		Test methods	69
R		Thermal properties	57
Record grooves	204	Thermoplastic	7
Recycling	49	Thermoset	6
Regranulate	166	Three-plate mold	82
Regrind	166	Tolerances	158
Reject	112	TPC-ET	31
Relaxation	147	TPE	27
Replacement cost calculation	116	TPE-A	32
Requirements	127	TPE-E	31
Ribs	155	TPE-O	27
Riveting	164	TPE-S	28
Rotation welding	161	TPE-U	30
Rotational cores	83	TPE-V	29
Rotational molding	125	TPO	27
Runner	87	TPS	28
		TPU	30
S		TPV	29
SBS	28	Trouble classification	187
Screen printing	78	Two-plate mold	81
Screw diameter	179	Two-component molding	76
Screw speed	179		
SEBS	28		
Semi-crystalline	7	U	
Service temperature	62	UL service temperature	62
Setpoint	186	Ultrasonic welding	160
SFP	191	Unmelts	172
Shut-off nozzle	167	UV resistance	54
Silver streaks	199		
Sink marks	197	V	
Six Sigma	216	V rating	63
SPC	215	Vacuum forming	126
Specific heat	8	Venting	91
Specific volume	8	Venting barrel	168
Splays	199	Vibration welding	161
Splays	200	Viscosity	64
Sprue	213	Visual inspection	68
Stack mold	83	VOIDS	197
Standard deviation	216		
Starch	43		

W	
Wall thickness	153
Warpage	211
Water injection molding	76
Water stain	206
Weight curve	176
Weld-lines	203
Wrong dimension	210
X	
XR chart (diagram)	216